

Ultrasonic sensors – Introduction

Mode of function

The ultrasound proximity switches belonging to the UM product series operate on the basis of the echo propagation time measurement.

Should the ultrasound impulses sent by the sensor hit an object, they are reflected. The sensor calculates the distance from the propagation time recorded between the sending out of the ultrasound impulse and the reception of the echo.

Depending on the output transformer, the distance measured is transformed into a current or voltage signal (analogue sensor) pro-

portional to the distance or the signal output is activated according to the set switching point.

All settings are carried out using two buttons (Touch-Control) situated on the side of the housing.

With UM 30 devices, all operating statuses are displayed by LEDs. With the models with signal output, it is possible to select between the N.O. and N.C. functions.

The analogue sensors distinguish themselves through their minimum linearity error and offer a choice between increasing and decreasing output characteristics.

Applications

As proximity switch

The classic operating mode uses the superior feature of background suppression that other sensor principles lack. Here the signal output is activated when the object is at less than the set switching distance. The switching point is accompanied by a hysteresis.

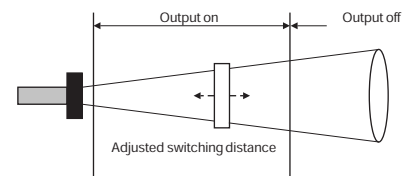

In window mode

The signal output is only set when the object is inside a window that is defined by two window limits. This enables e.g. the monitoring of the correct bottle size in a crate of bottles. Bottles that are too tall or too small are ejected.

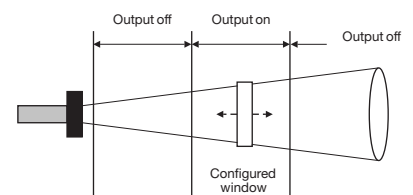

As two-way or retro-reflective sensor

Here an ultrasound sensor is used as a through beam. A special reflector is not used, a piece of sheet metal is sufficient. The sensor is set in window mode so that the reflector lies in the window. The retro-reflective ultrasound sensor delivers a signal as soon as an object completely covers the reflector. It is not important whether the object absorbs the sound or reflects it. This mode of operation is used with material that is difficult to detect and has an uneven surface, such as foam.

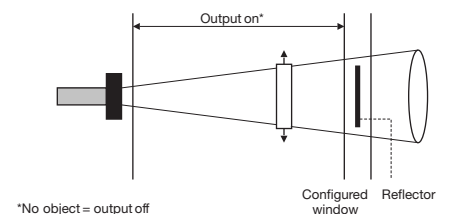

Ultrasound sensors with analogue output

With these models, a voltage (0 to 10 V) or a current (4 to 20 mA) is emitted - in proportion to the distance of the object. The window limits can be set and selected between a falling and increasing characteristic curve. The resolution is always 0.36 mm - regardless of the set width of the window.

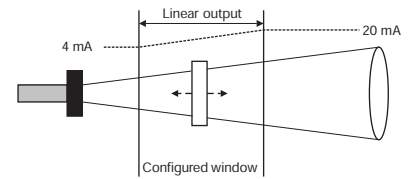

Installation

Ultrasound sensors can be installed and operated in any position. However, installation positions where dirt can build up on the surface of the sensor, should be avoided, as drops of water and incrustations can impair the correct functioning of the sensor. Light layers of dust and paint deposits do not generally have any effect.

If smooth surfaces are to be detected, the sensors are installed as vertically as possible, i.e. at an angle of 87° to 93° to the surface.

Rough surfaces, on the other hand, permit considerably greater angles. A surface is considered rough when its surface roughness is greater or equal to the wavelength of the ultrasound frequency.

The sound is then reflected in a diffuse manner, which can lead to a reduction of the scanning distance. In this case the max. permissible angular deviation and max. scanning distance should be determined.

Sound-absorbing substances (such as cotton wool or foam) can reduce the scanning distance further: Liquids and solid substances, on the other hand, reflect very well.

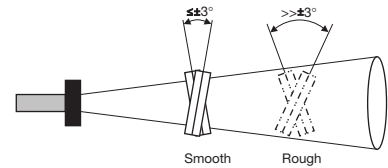

Installation intervals

The following table indicates the minimum interval between non-synchronised ultrasound sensors. Should the interval be less than the values indicated, the sensors can mutually affect one another.

Switching distance	Interval when installed next to one another (A)	Interval when installed opposite one another (B)
0,25 m	10 cm	≥ 100 cm
0,35 m	≥ 30 cm	≥ 170 cm
1,3 m	≥ 60 cm	≥ 540 cm
3,4 m	≥ 160 cm	≥ 1.600 cm
6,0 m	≥ 260 cm	≥ 3.000 cm

These are only guiding values. When tilted, the sound can also be „reflected“ to the neighbouring sensor. The minimum distance must then be determined by tests.

Some sensors enable synchronisation below one another and thus considerably smaller scanning intervals.

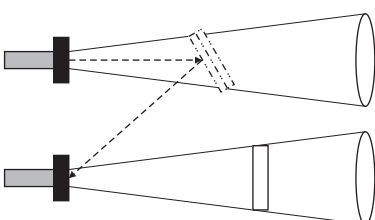

Ultrasonic sensors – Introduction

Use

UT 20 setting up the switching point:

1. Put object in front of the sensor
2. Hold button, yellow LED flashes slowly
3. Release button as soon as LED starts to flash faster (after 3 seconds)

Set up of the output (N.O./N.C.) function:

Hold button for 10 seconds, yellow LED flashes slowly, then faster. Output function switches after 10 seconds, yellow LED is either on or off.



UM 30-xxx P – set switching distance:

1. Press buttons T1 and T2 simultaneously for approx. 3 sec until the LED flashes yellow
2. Release buttons.
3. (*) Set switching distance:
T1 increases switching distance
T2 reduces switching distance

(If an object is within the switching distance, the LED lights up yellow, if the area is empty, it flashes.)

4. Do not press any key for 20 sec.: the newly set switching distance is stored in the EEPROM; the sensor then returns to normal operating mode.

UM 30-xxx PP – set switching distances:

1. Press buttons T1 and T2 simultaneously for approx. 3 sec until LEDs D1 and D2 flash yellow.
2. Release buttons: The LEDs flash alternately yellow.
3. Select signal output:

T1 selects signal output S1 (D1 yellow, D2 off)

T2 selects signal output S2 (D2 yellow, D1 off)

4. (*) Set switching distance:
T1 increases switching distance
T2 reduces switching distance

(If an object is within the switching distance, the LED lights up yellow, if the area is empty, it flashes.)

5. Do not press any key for 20 sec.: the newly set switching distance is stored in the EEPROM; the sensor then returns to normal operating mode.

Steps 1-5 must be carried out separately for both signal outputs.

UM 30-xxx P and UM 30-xxx PP – set N.O./N.C.:

1. Press buttons T1 and T2 simultaneously for approx. 10 sec until the LEDs stop flashing (permanently yellow).

2. Release buttons:

LED flashes green: N.O.

LED flashes red: N.C.

(With PP, LED D1 indicates the set function of signal output S1, D2 the setting of S2)

3. Button T1 alters the function of output 1, button T2 the function of output 2.

4. Do not press any key for 20 sec: the new functions are stored in the EEPROM; the sensor returns to normal operating mode.

Note:

In normal operating mode, a yellow LED signals that the pnp signal output has been activated.

UM 30-xxx A – set window limits:

First set the window limit closest to the sensor, then that furthest from the sensor. Attention:

The window limits can set at a minimum window width of 1 mm.

1. Press buttons T1 and T2 simultaneously for approx. 3 sec until the LEDs D1 and D2 flash yellow.

2. Release buttons: The LEDs flash alternately yellow.

3. Select window limit:

T2 selects setting of limit closest to sensor (D2 yellow, D1 off).

T1 selects setting of limit furthest from sensor (D1 yellow, D2 off).

4. (*) Set window limit:

T1 increases window limit

T2 reduces window limit

5. Do not press any key for 20 sec: the newly set window limit is stored in the EEPROM; the analogue sensor returns to normal operating mode.

Steps 1-5 are to be carried out separately for both window limits.

UM 30-xxx A – set output characteristics:

1. Press buttons T1 and T2 simultaneously for approx. 10 sec until the LEDs stop flashing (permanently yellow).

2. Release buttons:

LEDs flash green: decreasing output characteristics

LEDs flash red: increasing output characteristics

3. T1 selects decreasing output characteristics (20 - 4 mA or 10 - 0 V)

T2 selects increasing output characteristics (4 - 20 mA or 0 - 10 V)

4. Do not press any key for 20 sec: The new functions are stored in the EEPROM; the analogue sensor returns to normal operating mode.

Note:

If an object is within the window limits during normal mode, both LEDs light up green. If it is under the window limit closest to the sensor, LED D2 lights up red; if it is beyond the window limit furthest from the sensor, LED D1 lights up red.

When connecting the power supply, the analogue sensor tests the connected burden and switches automatically to current or voltage output.

* Setting aid:

If the buttons T1 and T2 are pressed simultaneously in the steps marked with *, the sensor stores the current distance value as the switching distance or window limit in the EEPROM and then immediately returns to normal operating mode (teach function).



Glossary

Accuracy

The (absolute) accuracy is the deviation between the true distance between the sensor and object and the distance measured by the sensor. The achievable accuracy is dependent on both the reflective properties of the object and the physical influence of the sonic speed in the air.

Objects with bad reflective properties or with surface roughness greater than the wavelengths of ultrasound frequency impair the achievable accuracy. A value cannot be indicated here. An uncertainty of several wavelengths of the ultrasound frequency used can serve as a thumb rule.

Air pressure

Acoustic speed depends on the air pressure in many areas.

Air temperature

Temperature has the greatest effect on the acoustic speed with 0.17%/K. Most ultrasound sensors are thus fitted with a temperature compensation, which enables an accuracy of better than 2%.

Relative air humidity

The effect of air humidity on accuracy can be neglected in comparison with the effect of air temperature.

Repeatability

The repeatability or reproducibility describes the deviation between the measured distance values, which were recorded under identical conditions over a set period of time. The repeatability is better than 0.15 %.

Ultrasonic sensors



Ultrasonic sensors

Smallest ultrasonic sensor in cubicle housing
Precise detection
Comfortable teach-in setting

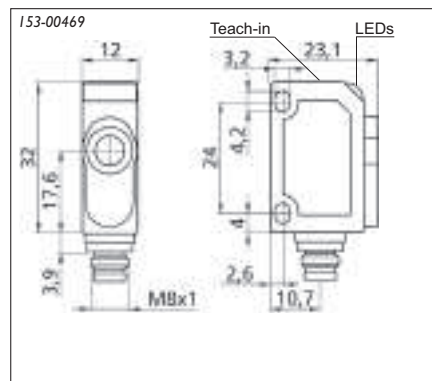
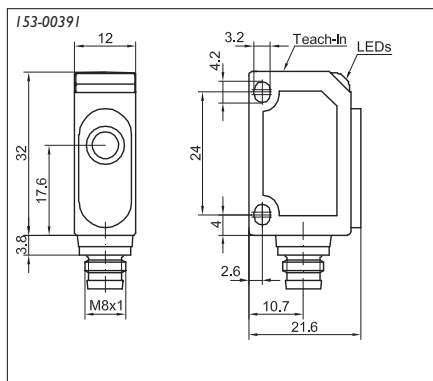

Housing (mm)	32 x 20 x 12	32 x 20 x 12	32 x 20 x 12	32 x 20 x 12
Scanning distance (mm)	20 ... 150	20 ... 150	50 ... 240	50 ... 240
Switching frequency (Hz)	25	25	25	25
Repeatability	+/- 0.15%	+/- 0.15%	+/- 0.15%	+/- 0.15%
Type of connection	plug M8 4 pins	plug M8 4 pins	plug M8 4 pins	plug M8 4 pins
Signal output	PNP	NPN	PNP	NPN
Output function	N.O./N.C.	N.O./N.C.	N.O./N.C.	N.O./N.C.
Sensor output	20 ... 30 V DC	20 ... 30 V DC	20 ... 30 V DC	20 ... 30 V DC
Power consumption (no load) (mA)	< 25	< 25	< 25	< 25
Max. output current (mA)	200	200	200	200
Typical switching hysteresis	2 mm	2 mm	2 mm	2 mm
Setting	teach-in	teach-in	teach-in	teach-in
Displays	LED green: function, LED yellow: switching	LED green: function, LED yellow: switching	LED green: function, LED yellow: switching	LED green: function, LED yellow: switching
Casing material	ABS	ABS	ABS	ABS
Protection standard	IP67	IP67	IP67	IP67
Ambient temperature	-20 ... +70°C	-20 ... +70°C	-20 ... +70°C	-20 ... +70°C

Order type

UT 20-150-PSM4

UT 20-150-NSM4

UT 20-240-PSM 4

UT 20-240-NSM4

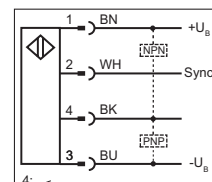
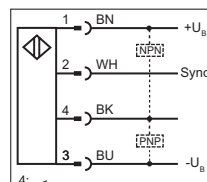
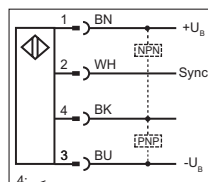
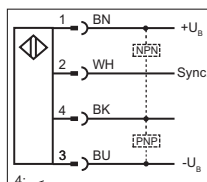
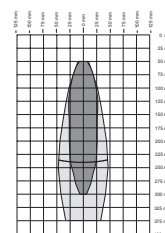
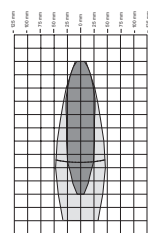
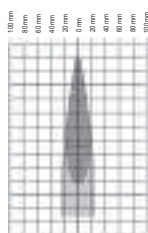
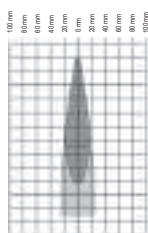

Ultrasonic sensors



Smallest ultrasonic sensor in cubicle housing
 Precise detection
 Comfortable teach-in setting

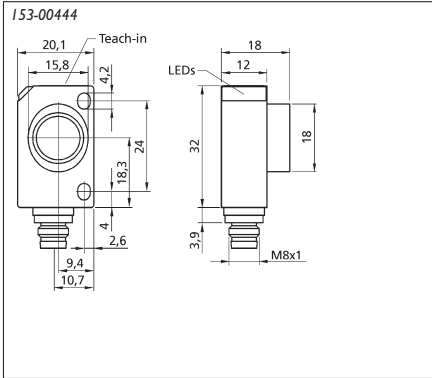

Housing (mm)	32 x 20 x 12	32 x 20 x 12
Scanning distance (mm)	120 ... 700	120 ... 700
Switching frequency (Hz)	14	14
Repeatability	+/- 0.15%	+/- 0.15%
Type of connection	plug M8 4 pins	plug M8 4 pins
Signal output	PNP	NPN
Output function	N.O./N.C.	N.O./N.C.
Sensor output	20 ... 30 V DC	20 ... 30 V DC
Power consumption (no load) (mA)	< 25	< 25
Max. output current (mA)	200	200
Typical switching hysteresis	2 mm	2 mm
Setting	teach-in	teach-in
Displays	LED green: function, LED yellow: switching	LED green: function, LED yellow: switching
Casing material	ABS	ABS
Protection standard	IP67	IP67
Ambient temperature	-20 ... +70°C	-20 ... +70°C

Order type

UT 20-700-PSM4

UT 20-700-NSM4

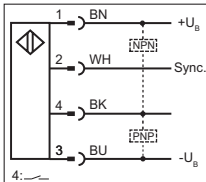
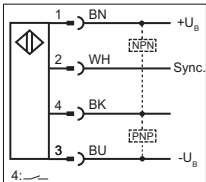
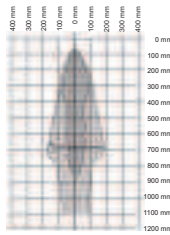
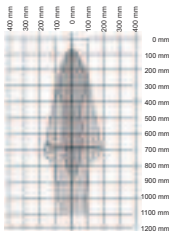

Ultrasonic sensors



Ultrasonic sensors

Smallest ultrasonic sensor in cubicle housing
 Precise detection
 Comfortable teach-in setting

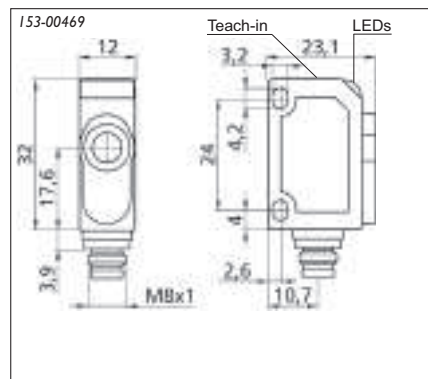
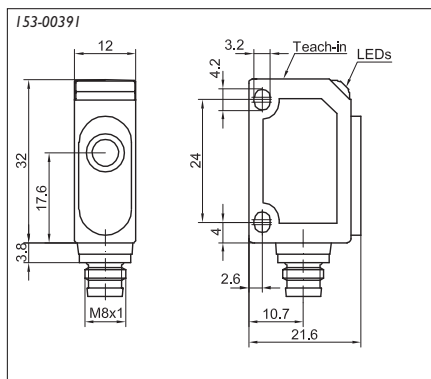

Housing (mm)	32 x 20 x 12	32 x 20 x 12	32 x 20 x 12	32 x 20 x 12
Scanning distance (mm)	20 ... 150	20 ... 150	50 ... 240	50 ... 240
Resolution	0.20 mm	0.20 mm	0.20 mm	0.20 mm
Repeatability	0.15%	0.15%	0.15%	0.15%
Type of connection	plug M8 4 pins	plug M8 4 pins	plug M8 4 pins	plug M8 4 pins
Sensor output	analogue 0 ... 10 V	analogue 4 ... 20 mA	analogue 0 ... 10 V	analogue 4 ... 20 mA
Power consumption (no load) (mA)	< 25	< 25	< 25	< 25
Max. output current (mA)	200	200	200	200
Typical switching hysteresis	2 mm	2 mm	2 mm	2 mm
Setting	teach-in	teach-in	teach-in	teach-in
Displays	LED green: function, LED yellow: switching	LED green: function, LED yellow: switching	LED green: function, LED yellow: switching	LED green: function, LED yellow: switching
Casing material	ABS	ABS	ABS	ABS
Protection standard	IP67	IP67	IP67	IP67
Ambient temperature	-20 ... +70°C	-20 ... +70°C	-20 ... +70°C	-20 ... +70°C
Order type	UT 20-150-AUM4	UT 20-150-AIM4	UT 20-240-AUM 4	UT 20-240-AIM4

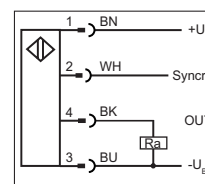
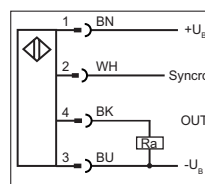
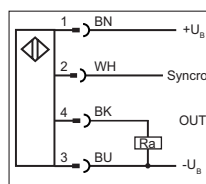
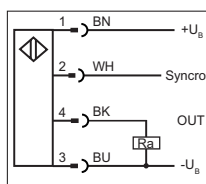
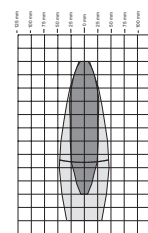
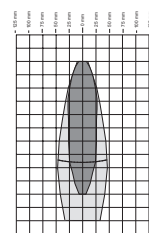
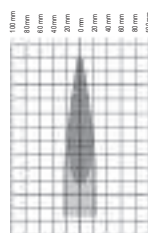
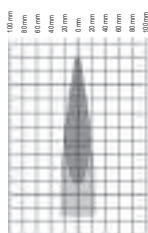

Ultrasonic sensors



Smallest ultrasonic sensor in cubicle housing
 Precise detection
 Comfortable teach-in setting

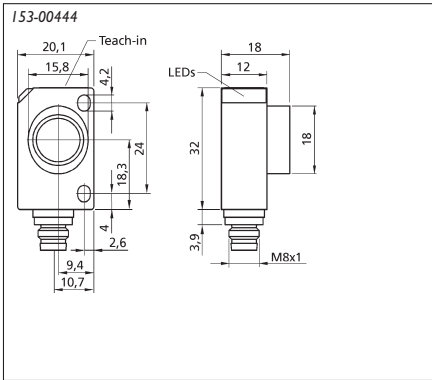

Housing (mm)	32 x 20 x 12	32 x 20 x 12
Scanning distance (mm)	120 ... 700	120 ... 7070
Resolution	0.20 mm	0.20 mm
Repeatability	0.15%	0.15%
Type of connection	plug M8 4 pins	plug M8 4 pins
Sensor output	analogue 0 ... 10 V	analogue 4 ... 20 mA
Power consumption (no load) (mA)	< 25	< 25
Max. output current (mA)	200	200
Typical switching hysteresis	2 mm	2 mm
Setting	teach-in	teach-in
Displays	LED green: function, LED yellow: switching	LED green: function, LED yellow: switching
Casing material	ABS	ABS
Protection standard	IP67	IP67
Ambient temperature	-20 ... +70°C	-20 ... +70°C

Order type **UT 20-700-AUM4** **UT 20-700-AIM4**

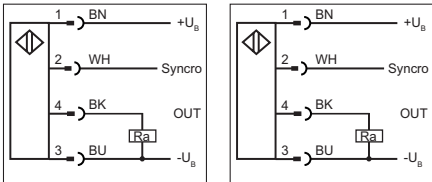
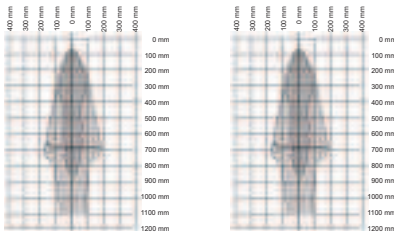



Ultrasonic sensors

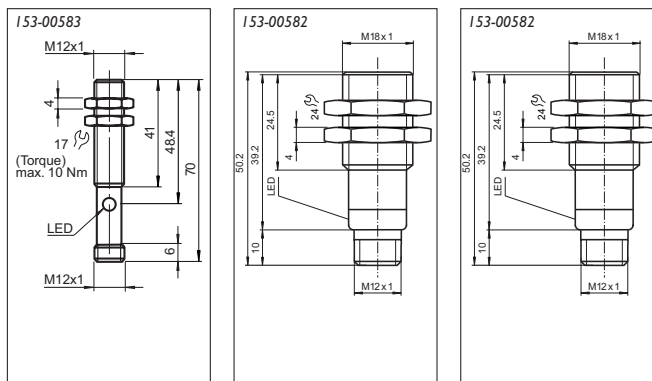

Housing	M12	M18	18
Scanning distance	30 ... 400 mm	30 ... 300 mm	50 ... 800 mm
Switching frequency (Hz)	8	13	8
Repeatability	< 1%	< 1%	< 1%
Type of connection	plug M12 4-pin	plug M12 4-pin	plug M12 4-pin
Signal output	PNP	PNP	PNP
Output function	N.O./N.C.	N.O./N.C.	N.O./N.C.
Sensor output	10 ... 30V DC	10 ... 30V DC	10 ... 30V DC
Power consumption no load (mA)	30	20	30
Max. output current (mA)	100	200	100
Typical switching hysteresis	1%	1%	1%
Setting	teach-in	teach-in	teach-in
Displays	LED yellow/LED red	LED yellow/LED red	LED yellow/LED red
Casing material	brass, nickelized	brass, nickelized	brass, nickelized
Protection standard	IP 65	IP 65	IP 65
Ambient temperature	-25 ... 70 °C	-25 ... 70 °C	-25 ... 70 °C
Order type	UT 12-370-PSL4	UT 18-270-PSL4	UT 18-750-PSL4

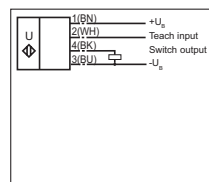
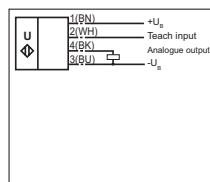
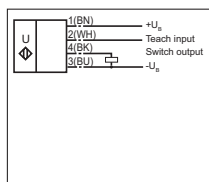
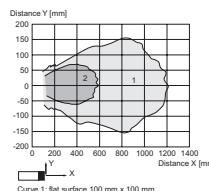
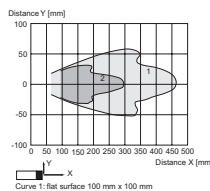
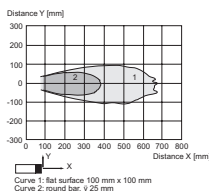

Ultrasonic sensors



Ultrasonic sensors

Cylindrical design
 Robust metal housing
 U30 with Touch Control
 U30: N.O./N.C. selectable
 Protective wiring
 Analogue: selectable increasing or falling output characteristics
 Analogue: Minimum linearity distortion
 Slight temperature drift of 0.17%/K

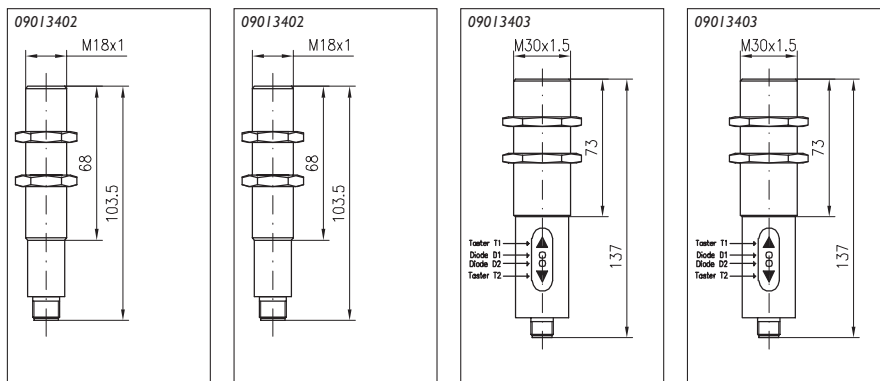

Housing (mm)	M 18	M 18	M 30	M 30
Scanning distance (mm)	30 to 250	30 to 250	60 to 350	60 to 350
Special features	two fixed switching interval settings	two fixed switching interval settings	automatic change-over power/voltage	
Switching frequency (Hz)	30	30		8
Repeatability	< 1mm	< 1mm	+/- 1mm	+/- 1mm
Type of connection	M12 4-pin plug	M12 4-pin plug	M12 5-pin plug	M12 5-pin plug
Signal output	1 x PNP	1 x PNP	analogue	1 x PNP
Output function	N.O.	N.O.	Power: 4 - 20 mA (load <500 Ohm) Voltage: 0 -10V (load > 100 kOhm)	N.O./N.C. (N.O. pre-set)
Sensor output	12 to 30V DC	12 to 30V DC	12 to 30V DC	12 to 30V DC
Power consumption (no load) (mA)	< 60	< 60	< 70	< 60
Max. output current (mA)	500	500		200
Typical switching hysteresis	2 mm	2 mm	5 mm	5 mm
Setting	control input	control input	2 press-buttons	2 press-buttons
Displays			2 x three-colour LEDs	1 x three-colour LED
Casing material	nickel-plated brass	stainless steel	nickel-plated brass	nickel-plated brass
Protection standard	IP65	IP65	IP65	IP65
Ambient temperature	-20 to +70°C	-20 to +70°C	-20 to +70°C	-20 to +70°C

Order type

UM 18-60/250-CD-HP

UM 18-60/250-CD-HP-E

UM 30-300 A-HP

UM 30-300 P-HP

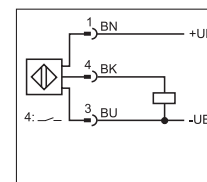
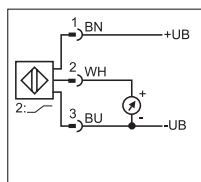
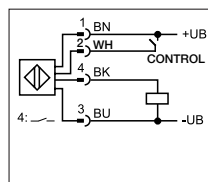
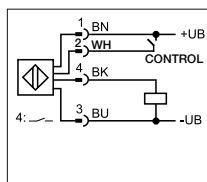
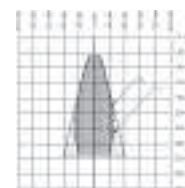
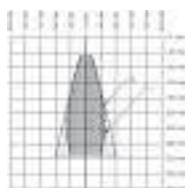
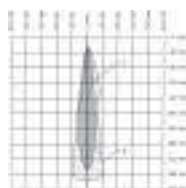
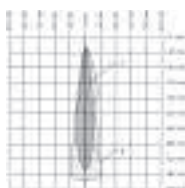

Ultrasonic sensors



Ultrasonic sensors

Cylindrical design
 Robust metal housing
 U30 with Touch Control
 U30: N.O./N.C. selectable
 Protective wiring
 Analogue: selectable increasing or falling output characteristics
 Analogue: Minimum linearity distortion
 Slight temperature drift of 0.17%/K

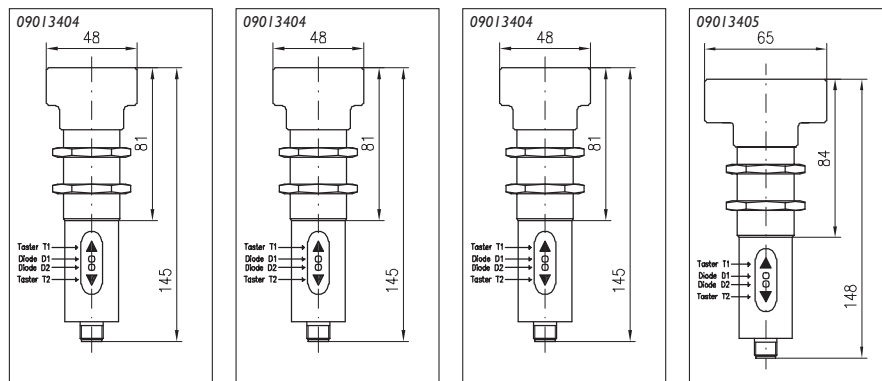

Scanning distance (mm)	350 to 3400	350 to 3400	350 to 3400	800 to 6000
Special features		automatic change-over power/voltage		automatic change-over power/voltage
Switching frequency (Hz)		4	4	
Repeatability	+/- 3mm	+/- 3mm	+/- 3mm	+/- 4mm
Type of connection	M12 4-pin plug	M12 4-pin plug	M12 4-pin plug	M12 4-pin plug
Signal output	analogue	1 x PNP	2 x PNP	analogue
Output function	Power: 4 - 20 mA (load <500 Ohm) Voltage: 0 -10V (load > 100 kOhm)	N.O./N.C. (N.O. pre-set)	N.O./N.C. (N.O. pre-set)	Power: 4 - 20 mA (load <500 Ohm) Voltage: 0 -10V (load > 100 kOhm)
Sensor output	12 to 30V DC	12 to 30V DC	12 to 30V DC	12 to 30V DC
Power consumption (no load) (mA)	< 70	< 60	< 60	< 70
Max. output current (mA)		200	200	
Typical switching hysteresis	50 mm	50 mm	50 mm	100 mm
Setting	2 press-buttons	2 press-buttons	2 press-buttons	2 press-buttons
Displays	2 x three-colour LEDs	1 x three-colour LED	2 x three-colour LEDs	2 x three-colour LEDs
Casing material	nickel-plated brass	nickel-plated brass	nickel-plated brass	nickel-plated brass
Protection standard	IP65	IP65	IP65	IP65
Ambient temperature	-20 to +70°C	-20 to +70°C	-20 to +70°C	-20 to +70°C
Order type	UM 30-3000 A-HP	UM 30-3000 P-HP	UM 30-3000 PP-HP	UM 30-6000 A-HP

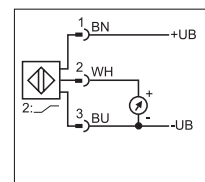
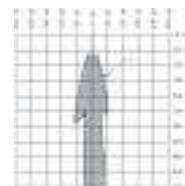
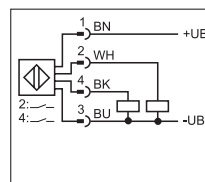
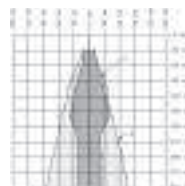
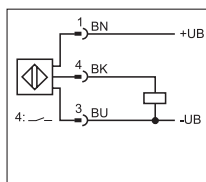
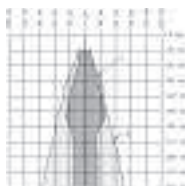
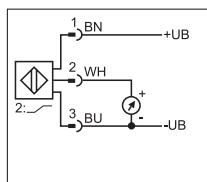
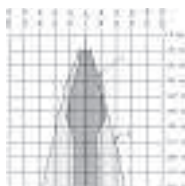



Ultrasonic sensors

- Cylindrical design
- Robust metal housing
- U30 with Touch Control
- U30: N.O./N.C. selectable
- Protective wiring
- Analogue: selectable increasing or falling output characteristics
- Analogue: Minimum linearity distortion
- Slight temperature drift of 0.17%/K

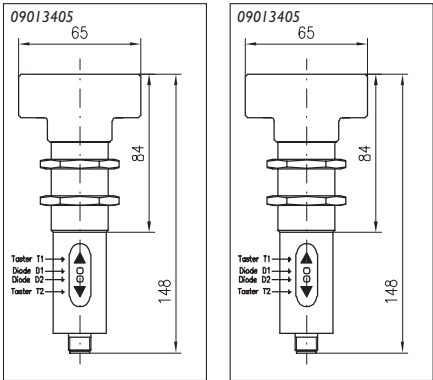

Housing (mm)	M 30	M 30
Scanning distance (mm)	800 to 6000	800 to 6000
Switching frequency (Hz)	2	2
Repeatability	+/- 4mm	+/- 4mm
Type of connection	M12 4-pin plug	M12 4-pin plug
Signal output	1 x PNP	2 x PNP
Output function	N.O./N.C. (N.O. pre-set)	N.O./N.C. (N.O. pre-set)
Sensor output	12 to 30V DC	12 to 30V DC
Power consumption (no load) (mA)	< 60	< 60
Max. output current (mA)	200	200
Typical switching hysteresis	100 mm	100 mm
Setting	2 press-buttons	2 press-buttons
Displays	2 x three-colour LEDs	2 x three-colour LEDs
Casing material	nickel-plated brass	nickel-plated brass
Protection standard	IP65	IP65
Ambient temperature	-20 to +70°C	-20 to +70°C

Order type **UM 30-6000 P-HP** **UM 30-6000 PP-HP**

